

# Technische Information / Technical Information

IGBT-Module  
IGBT-Modules

## FP25R12KS4C

eupec



### Elektrische Eigenschaften / Electrical properties

#### Höchstzulässige Werte / Maximum rated values

##### Diode Gleichrichter/ Diode Rectifier

|  |  |             |      |                      |
|--|--|-------------|------|----------------------|
| Periodische Rückw. Spitzensperrspannung<br>repetitive peak reverse voltage |  | $V_{RRM}$   | 1600 | V                    |
| Durchlaßstrom Grenzeffektivwert<br>RMS forward current per chip            |  | $I_{FRMSM}$ | 40   | A                    |
| Dauergleichstrom<br>DC forward current                                     | $T_C = 80^\circ\text{C}$                         | $I_d$       | 25   | A                    |
| Stoßstrom Grenzwert<br>surge forward current                               | $t_p = 10\text{ ms}, T_{vj} = 25^\circ\text{C}$  | $I_{FSM}$   | 300  | A                    |
|  | $t_p = 10\text{ ms}, T_{vj} = 150^\circ\text{C}$ |             | 230  | A                    |
| Grenzlastintegral<br>$I^2t$ - value  | $t_p = 10\text{ ms}, T_{vj} = 25^\circ\text{C}$  | $I^2t$      | 450  | $\text{A}^2\text{s}$ |
|  | $t_p = 10\text{ ms}, T_{vj} = 150^\circ\text{C}$ |             | 260  | $\text{A}^2\text{s}$ |

##### Transistor Wechselrichter/ Transistor Inverter

|  |   |              |         |   |
|--|---|--------------|---------|---|
| Kollektor-Emitter-Sperrspannung<br>collector-emitter voltage             |   | $V_{CES}$    | 1200    | V |
| Kollektor-Dauergleichstrom<br>DC-collector current                       | $T_C = 80^\circ\text{C}$                    | $I_{C,nom.}$ | 25      | A |
|  | $T_C = 25^\circ\text{C}$                    | $I_C$        | 40      | A |
| Periodischer Kollektor Spitzenstrom<br>repetitive peak collector current | $t_p = 1\text{ ms}, T_C = 80^\circ\text{C}$ | $I_{CRM}$    | 50      | A |
| Gesamt-Verlustleistung<br>total power dissipation                        | $T_C = 25^\circ\text{C}$                    | $P_{tot}$    | 230     | W |
| Gate-Emitter-Spitzenspannung<br>gate-emitter peak voltage                |   | $V_{GES}$    | +/- 20V | V |

##### Diode Wechselrichter/ Diode Inverter

|  |  |           |     |                      |
|--|--|-----------|-----|----------------------|
| Dauergleichstrom<br>DC forward current                     | $T_C = 80^\circ\text{C}$   | $I_F$     | 25  | A                    |
| Periodischer Spitzenstrom<br>repetitive peak forw. current | $t_p = 1\text{ ms}$  | $I_{FRM}$ | 50  | A                    |
| Grenzlastintegral<br>$I^2t$ - value                        | $V_R = 0\text{V}, t_p = 10\text{ms}, T_{vj} = 125^\circ\text{C}$ | $I^2t$    | 125 | $\text{A}^2\text{s}$ |

##### Transistor Brems-Chopper/ Transistor Brake-Chopper

|  |   |              |         |   |
|--|---|--------------|---------|---|
| Kollektor-Emitter-Sperrspannung<br>collector-emitter voltage             |   | $V_{CES}$    | 1200    | V |
| Kollektor-Dauergleichstrom<br>DC-collector current                       | $T_C = 80^\circ\text{C}$                    | $I_{C,nom.}$ | 12,5    | A |
|  | $T_C = 25^\circ\text{C}$                    | $I_C$        | 25      | A |
| Periodischer Kollektor Spitzenstrom<br>repetitive peak collector current | $t_p = 1\text{ ms}, T_C = 80^\circ\text{C}$ | $I_{CRM}$    | 25      | A |
| Gesamt-Verlustleistung<br>total power dissipation                        | $T_C = 25^\circ\text{C}$                    | $P_{tot}$    | 100     | W |
| Gate-Emitter-Spitzenspannung<br>gate-emitter peak voltage                |   | $V_{GES}$    | +/- 20V | V |

##### Diode Brems-Chopper/ Diode Brake-Chopper

|  |                          |           |    |   |
|--|--------------------------|-----------|----|---|
| Dauergleichstrom<br>DC forward current                     | $T_C = 80^\circ\text{C}$ | $I_F$     | 10 | A |
| Periodischer Spitzenstrom<br>repetitive peak forw. current | $t_p = 1\text{ ms}$      | $I_{FRM}$ | 20 | A |

prepared by: A.Schulz

date of publication: 2001-11-28

approved by: M.Hierholzer

revision: 2

# Technische Information / Technical Information

IGBT-Module  
IGBT-Modules

## FP25R12KS4C

eupec



### Modul Isolation/ Module Isolation

|  |  |                   |     |    |
|--|--|-------------------|-----|----|
| Isolations-Prüfspannung<br>insulation test voltage | RMS, f = 50 Hz, t = 1 min.<br>NTC connected to Baseplate | V <sub>ISOL</sub> | 2,5 | kV |
|--|--|-------------------|-----|----|

### Elektrische Eigenschaften / Electrical properties

#### Charakteristische Werte / Characteristic values

#### Diode Gleichrichter/ Diode Rectifier

|  |  |                    |   | min. | typ. | max. |  |
|--|--|--------------------|---|------|------|------|--|
| Durchlaßspannung<br>forward voltage  | T <sub>vj</sub> = 150°C, I <sub>F</sub> = 25 A   | V <sub>F</sub>     | - | 1,05 | -    | V    |  |
| Schleusenspannung<br>threshold voltage                                       | T <sub>vj</sub> = 150°C                          | V <sub>(TO)</sub>  | - | -    | 0,8  | V    |  |
| Ersatzwiderstand<br>slope resistance   | T <sub>vj</sub> = 150°C                          | r <sub>T</sub>     | - | -    | 10,5 | mΩ   |  |
| Sperrstrom<br>reverse current  | T <sub>vj</sub> = 150°C, V <sub>R</sub> = 1600 V | I <sub>R</sub>     | - | 2    | -    | mA   |  |
| Modul Leitungswiderstand, Anschlüsse-Chip<br>lead resistance, terminals-chip | T <sub>C</sub> = 25°C                            | R <sub>AA+CC</sub> | - | 8    | -    | mΩ   |  |

#### Transistor Wechselrichter/ Transistor Inverter

|  |  |                     |     | min. | typ. | max. |  |
|--|--|---------------------|-----|------|------|------|--|
| Kollektor-Emitter Sättigungsspannung<br>collector-emitter saturation voltage | V <sub>GE</sub> = 15V, T <sub>vj</sub> = 25°C, I <sub>C</sub> = 25 A   | V <sub>CE sat</sub> | -   | 3,2  | 3,7  | V    |  |
|  | V <sub>GE</sub> = 15V, T <sub>vj</sub> = 125°C, I <sub>C</sub> = 25 A  |                     | -   | 3,85 | -    | V    |  |
| Gate-Schwellenspannung<br>gate threshold voltage                             | V <sub>CE</sub> = V <sub>GE</sub> , T <sub>vj</sub> = 25°C, I <sub>C</sub> = 1 mA  | V <sub>GE(TO)</sub> | 4,5 | 5,5  | 6,5  | V    |  |
| Eingangskapazität<br>input capacitance                                       | f = 1MHz, T <sub>vj</sub> = 25°C<br>V <sub>CE</sub> = 25 V, V <sub>GE</sub> = 0 V  | C <sub>ies</sub>    | -   | 1,5  | -    | nF   |  |
| Kollektor-Emitter Reststrom<br>collector-emitter cut-off current             | V <sub>GE</sub> = 0V, T <sub>vj</sub> = 25°C, V <sub>CE</sub> = 1200 V   | I <sub>CES</sub>    | -   | -    | 5    | mA   |  |
| Gate-Emitter Reststrom<br>gate-emitter leakage current                       | V <sub>CE</sub> = 0V, V <sub>GE</sub> = 20V, T <sub>vj</sub> = 25°C  | I <sub>GES</sub>    | -   | -    | 400  | nA   |  |
| Einschaltverzögerungszeit (ind. Last)<br>turn on delay time (inductive load) | I <sub>C</sub> = I <sub>Nenn</sub> , V <sub>CC</sub> = 600 V   | t <sub>d,on</sub>   | -   | 60   | -    | ns   |  |
|  | V <sub>GE</sub> = ±15V, T <sub>vj</sub> = 25°C, R <sub>G</sub> = 27 Ohm  |                     |     |      |      |      |  |
|  | V <sub>GE</sub> = ±15V, T <sub>vj</sub> = 125°C, R <sub>G</sub> = 27 Ohm   |                     |     |      |      |      |  |
| Anstiegszeit (induktive Last)<br>rise time (inductive load)                  | I <sub>C</sub> = I <sub>Nenn</sub> , V <sub>CC</sub> = 600 V   | t <sub>r</sub>      | -   | 50   | -    | ns   |  |
|  | V <sub>GE</sub> = ±15V, T <sub>vj</sub> = 25°C, R <sub>G</sub> = 27 Ohm  |                     |     |      |      |      |  |
|  | V <sub>GE</sub> = ±15V, T <sub>vj</sub> = 125°C, R <sub>G</sub> = 27 Ohm   |                     |     |      |      |      |  |
| Abschaltverzögerungszeit (ind. Last)<br>turn off delay time (inductive load) | I <sub>C</sub> = I <sub>Nenn</sub> , V <sub>CC</sub> = 600 V   | t <sub>d,off</sub>  | -   | 340  | -    | ns   |  |
|  | V <sub>GE</sub> = ±15V, T <sub>vj</sub> = 25°C, R <sub>G</sub> = 27 Ohm  |                     |     |      |      |      |  |
|  | V <sub>GE</sub> = ±15V, T <sub>vj</sub> = 125°C, R <sub>G</sub> = 27 Ohm   |                     |     |      |      |      |  |
| Fallzeit (induktive Last)<br>fall time (inductive load)                      | I <sub>C</sub> = I <sub>Nenn</sub> , V <sub>CC</sub> = 600 V   | t <sub>f</sub>      | -   | 50   | -    | ns   |  |
|  | V <sub>GE</sub> = ±15V, T <sub>vj</sub> = 25°C, R <sub>G</sub> = 27 Ohm  |                     |     |      |      |      |  |
|  | V <sub>GE</sub> = ±15V, T <sub>vj</sub> = 125°C, R <sub>G</sub> = 27 Ohm   |                     |     |      |      |      |  |
| Einschaltverlustenergie pro Puls<br>turn-on energy loss per pulse            | I <sub>C</sub> = I <sub>Nenn</sub> , V <sub>CC</sub> = 600 V<br>V <sub>GE</sub> = ±15V, T <sub>vj</sub> = 125°C, R <sub>G</sub> = 27 Ohm<br>L <sub>S</sub> = 75 nH | E <sub>on</sub>     | -   | 3,2  | -    | mWs  |  |
| Abschaltverlustenergie pro Puls<br>turn-off energy loss per pulse            | I <sub>C</sub> = I <sub>Nenn</sub> , V <sub>CC</sub> = 600 V<br>V <sub>GE</sub> = ±15V, T <sub>vj</sub> = 125°C, R <sub>G</sub> = 27 Ohm<br>L <sub>S</sub> = 75 nH | E <sub>off</sub>    | -   | 1,6  | -    | mWs  |  |
| Kurzschlußverhalten<br>SC Data   | t <sub>p</sub> ≤ 10µs, V <sub>GE</sub> ≤ 15V, R <sub>G</sub> = 27 Ohm<br>T <sub>vj</sub> ≤ 125°C, V <sub>CC</sub> = 720 V<br>di/dt = 2000 A/µs                     | I <sub>SC</sub>     | -   | 160  | -    | A    |  |

# Technische Information / Technical Information

IGBT-Module  
IGBT-Modules

## FP25R12KS4C

eupec

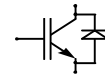

### Elektrische Eigenschaften / Electrical properties

#### Charakteristische Werte / Characteristic values

|  |   | min.            | typ.        | max.        |             |                      |
|--|---|-----------------|-------------|-------------|-------------|----------------------|
| Modulinduktivität<br>stray inductance module                                 |   | $L_{\sigma CE}$ | -           | -           | 100         | nH                   |
| Modul Leitungswiderstand, Anschlüsse-Chip<br>lead resistance, terminals-chip | $T_C = 25^\circ C$  | $R_{CC+EE}$     | -           | 11          | -           | m $\Omega$           |
| <b>Diode Wechselrichter/ Diode Inverter</b>                                  |   |                 | <b>min.</b> | <b>typ.</b> | <b>max.</b> |                      |
| Durchlaßspannung<br>forward voltage  | $V_{GE} = 0V, T_{vj} = 25^\circ C, I_F = 25 A$<br>$V_{GE} = 0V, T_{vj} = 125^\circ C, I_F = 25 A$   | $V_F$           | -           | 2,05<br>1,9 | 2,4<br>-    | V<br>V               |
| Rückstromspitze<br>peak reverse recovery current                             | $I_F = I_{Nenn}, -di_F/dt = 1000A/\mu s$<br>$V_{GE} = -10V, T_{vj} = 25^\circ C, V_R = 600 V$<br>$V_{GE} = -10V, T_{vj} = 125^\circ C, V_R = 600 V$ | $I_{RM}$        | -           | 30<br>35    | -<br>-      | A<br>A               |
| Sperrverzögerungsladung<br>recovered charge                                  | $I_F = I_{Nenn}, -di_F/dt = 1000A/\mu s$<br>$V_{GE} = -10V, T_{vj} = 25^\circ C, V_R = 600 V$<br>$V_{GE} = -10V, T_{vj} = 125^\circ C, V_R = 600 V$ | $Q_r$           | -           | 2,1<br>4,5  | -<br>-      | $\mu As$<br>$\mu As$ |
| Abschaltenergie pro Puls<br>reverse recovery energy                          | $I_F = I_{Nenn}, -di_F/dt = 1000A/\mu s$<br>$V_{GE} = -10V, T_{vj} = 25^\circ C, V_R = 600 V$<br>$V_{GE} = -10V, T_{vj} = 125^\circ C, V_R = 600 V$ | $E_{RQ}$        | -           | 0,75<br>1,6 | -<br>-      | mWs<br>mWs           |
| <b>Transistor Brems-Chopper/ Transistor Brake-Chopper</b>                    |   |                 | <b>min.</b> | <b>typ.</b> | <b>max.</b> |                      |
| Kollektor-Emitter Sättigungsspannung<br>collector-emitter saturation voltage | $V_{GE} = 15V, T_{vj} = 25^\circ C, I_C = 12,5 A$<br>$V_{GE} = 15V, T_{vj} = 125^\circ C, I_C = 12,5 A$   | $V_{CE sat}$    | -           | 2,7<br>3,1  | 3,15<br>-   | V<br>V               |
| Gate-Schwellenspannung<br>gate threshold voltage                             | $V_{CE} = V_{GE}, T_{vj} = 25^\circ C, I_C = 0,35mA$  | $V_{GE(TO)}$    | 4,5         | 5,5         | 6,5         | V                    |
| Eingangskapazität<br>input capacitance                                       | $f = 1MHz, T_{vj} = 25^\circ C$<br>$V_{CE} = 25 V, V_{GE} = 0 V$  | $C_{ies}$       | -           | 0,6         | -           | nF                   |
| Kollektor-Emitter Reststrom<br>collector-emitter cut-off current             | $V_{GE} = 0V, T_{vj} = 25^\circ C, V_{CE} = 1200 V$<br>$V_{GE} = 0V, T_{vj} = 125^\circ C, V_{CE} = 1200 V$   | $I_{CES}$       | -           | 0,5<br>0,8  | 500<br>-    | $\mu A$<br>mA        |
| Gate-Emitter Reststrom<br>gate-emitter leakage current                       | $V_{CE} = 0V, V_{GE} = 20V, T_{vj} = 25^\circ C$  | $I_{GES}$       | -           | -           | 300         | nA                   |
| Schaltverluste und -bedingungen<br>Switching losses and conditions           | siehe Datenblatt (Wechselrichter)<br>see datasheet (inverter)   | BSM10GP120      |             |             |             |                      |
| <b>Diode Brems-Chopper/ Diode Brake-Chopper</b>                              |   |                 | <b>min.</b> | <b>typ.</b> | <b>max.</b> |                      |
| Durchlaßspannung<br>forward voltage  | $T_{vj} = 25^\circ C, I_F = 12,5 A$<br>$T_{vj} = 125^\circ C, I_F = 12,5 A$   | $V_F$           | -           | 2,35<br>2,3 | 2,65<br>-   | V<br>V               |
| Schaltverluste und -bedingungen<br>Switching losses and conditions           | siehe Datenblatt (Wechselrichter)<br>see datasheet (inverter)   | BSM10GP120      |             |             |             |                      |
| <b>NTC-Widerstand/ NTC-Thermistor</b>  |   |                 | <b>min.</b> | <b>typ.</b> | <b>max.</b> |                      |
| Nennwiderstand<br>rated resistance   | $T_C = 25^\circ C$  | $R_{25}$        | -           | 5           | -           | k $\Omega$           |
| Abweichung von $R_{100}$<br>deviation of $R_{100}$                           | $T_C = 100^\circ C, R_{100} = 493 \Omega$   | $\Delta R/R$    | -5          |             | 5           | %                    |
| Verlustleistung<br>power dissipation   | $T_C = 25^\circ C$  | $P_{25}$        |             |             | 20          | mW                   |
| B-Wert<br>B-value  | $R_2 = R_1 \exp [B(1/T_2 - 1/T_1)]$   | $B_{25/50}$     |             | 3375        |             | K                    |

# Technische Information / Technical Information

IGBT-Module  
IGBT-Modules

## FP25R12KS4C

eupec

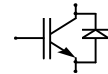

### Thermische Eigenschaften / Thermal properties

|  |                                |                            |     | min. | typ. | max. |  |
|--|--------------------------------|----------------------------|-----|------|------|------|--|
| Innerer Wärmewiderstand<br>thermal resistance, junction to case        | Gleichr. Diode/ Rectif. Diode  | $R_{thJC}$                 | -   | -    | 1    | K/W  |  |
|  | Trans. Wechr./ Trans. Inverter |                            | -   | -    | 0,55 | K/W  |  |
|  | Diode Wechr./ Diode Inverter   |                            | -   | -    | 1,2  | K/W  |  |
|  | Trans. Bremse/ Trans. Brake    |                            | -   | -    | 1,2  | K/W  |  |
|  | Diode Bremse/ Diode Brake      |                            | -   | -    | 2,3  | K/W  |  |
| Übergangs-Wärmewiderstand<br>thermal resistance, case to heatsink      | Gleichr. Diode/ Rectif. Diode  | $R_{thCK}$                 | -   | 0,08 | -    | K/W  |  |
|  | Trans. Wechr./ Trans. Inverter | $\lambda_{Paste}=1W/m^2K$  | -   | 0,04 | -    | K/W  |  |
|  | Diode Wechr./ Diode Inverter   | $\lambda_{grease}=1W/m^2K$ | -   | 0,08 | -    | K/W  |  |
| Höchstzulässige Sperrschichttemperatur<br>maximum junction temperature |                                | $T_{vj\ max}$              | -   | -    | 150  | °C   |  |
| Betriebstemperatur<br>operation temperature                            |                                | $T_{vj\ op}$               | -40 | -    | 125  | °C   |  |
| Lagertemperatur<br>storage temperature                                 |                                | $T_{stg}$                  | -40 | -    | 125  | °C   |  |

### Mechanische Eigenschaften / Mechanical properties

|  |  |   |  |           |    |
|--|--|---|--|-----------|----|
| Innere Isolation<br>internal insulation                  |  |   |  | $Al_2O_3$ |    |
| CTI<br>comperative tracking index                        |  |   |  | 225       |    |
| Anzugsdrehmoment f. mech. Befestigung<br>mounting torque |  | M |  | 3<br>±10% | Nm |
| Gewicht<br>weight  |  | G |  | 180       | g  |



Ausgangskennlinienfeld Wechselr. (typisch)

$I_C = f(V_{CE})$

Output characteristic Inverter (typical)

$V_{GE} = 15\text{ V}$

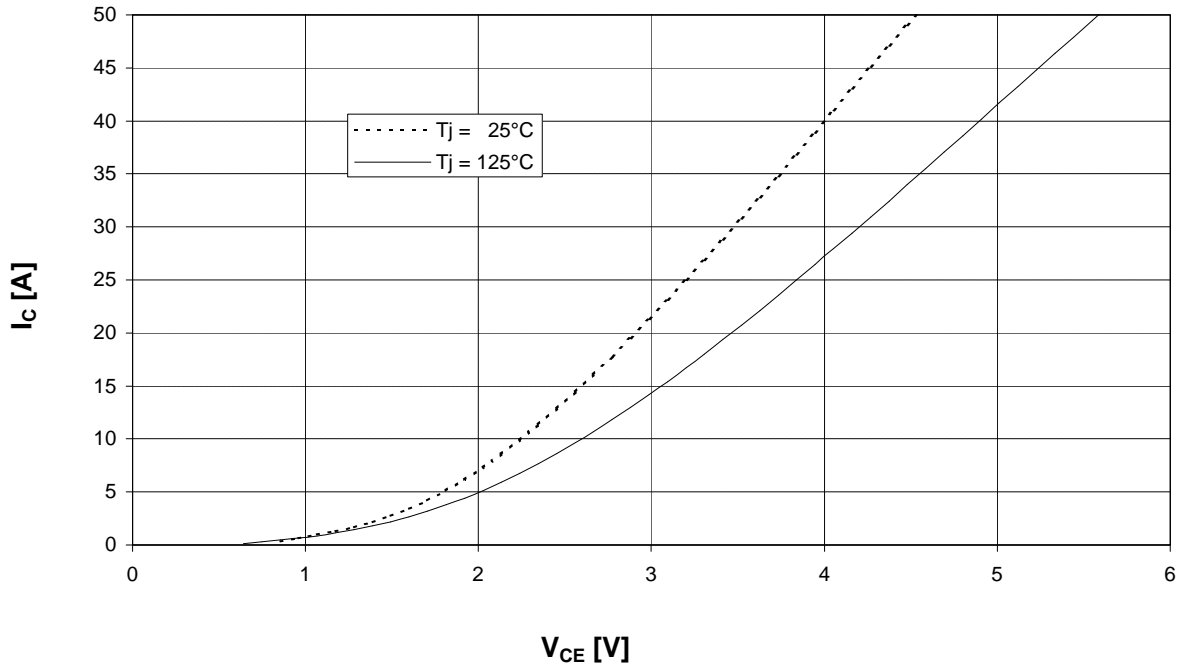

Ausgangskennlinienfeld Wechselr. (typisch)

$I_C = f(V_{CE})$

Output characteristic Inverter (typical)

$T_{vj} = 125^\circ\text{C}$

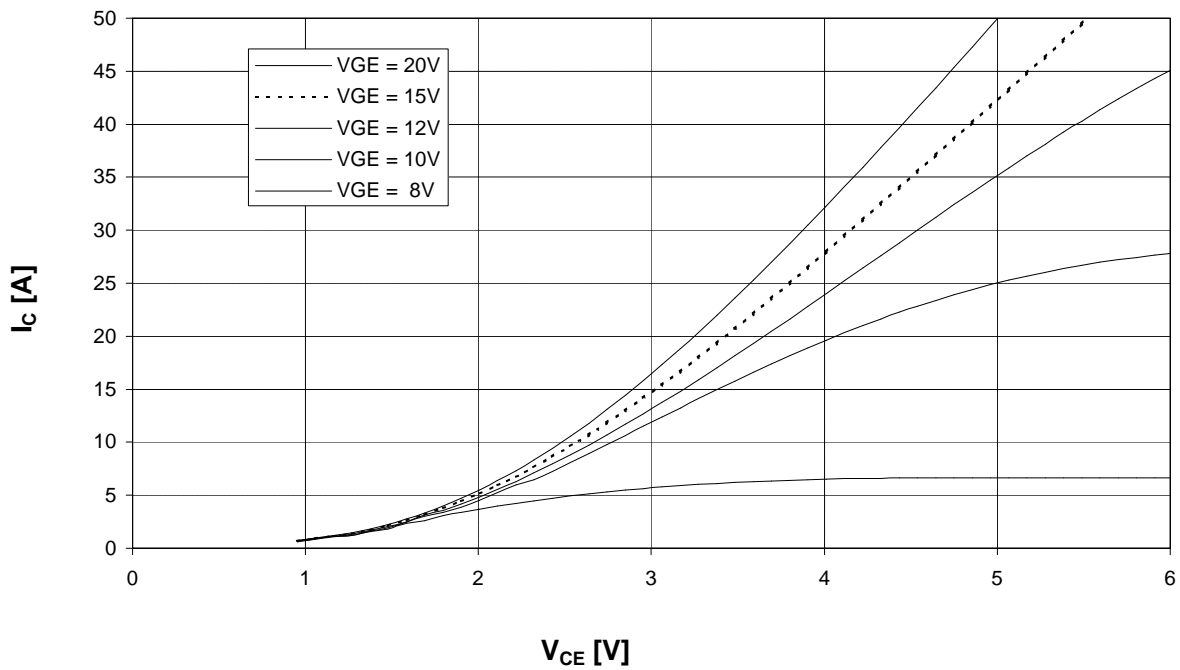

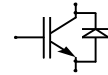

Übertragungscharakteristik Wechselr. (typisch)

$I_C = f(V_{GE})$

Transfer characteristic Inverter (typical)

$V_{CE} = 20\text{ V}$

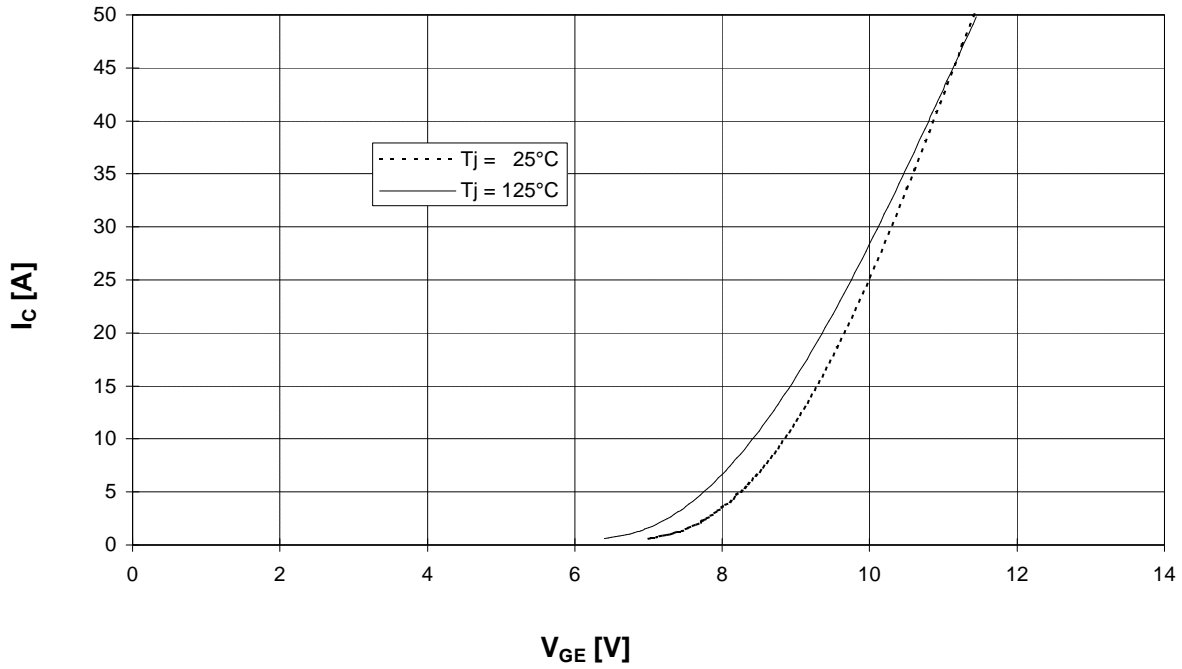

Durchlaßkennlinie der Freilaufdiode Wechselr. (typisch)

$I_F = f(V_F)$

Forward characteristic of FWD Inverter (typical)

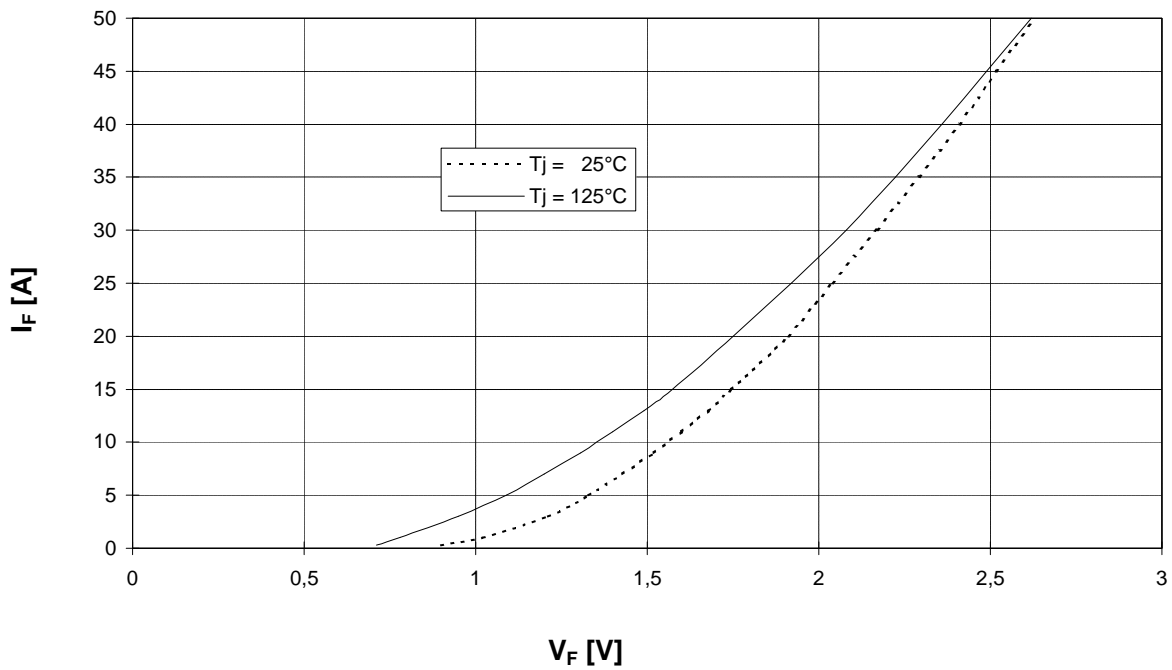

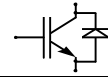

**Schaltverluste Wechselr. (typisch)**  $E_{on} = f(I_c), E_{off} = f(I_c), E_{rec} = f(I_c)$   $V_{CC} = 600\text{ V}$   
**Switching losses Inverter (typical)**  $T_j = 125^\circ\text{C}, V_{GE} = \pm 15\text{ V}, R_{Gon} = R_{Goff} = 27\text{ Ohm}$

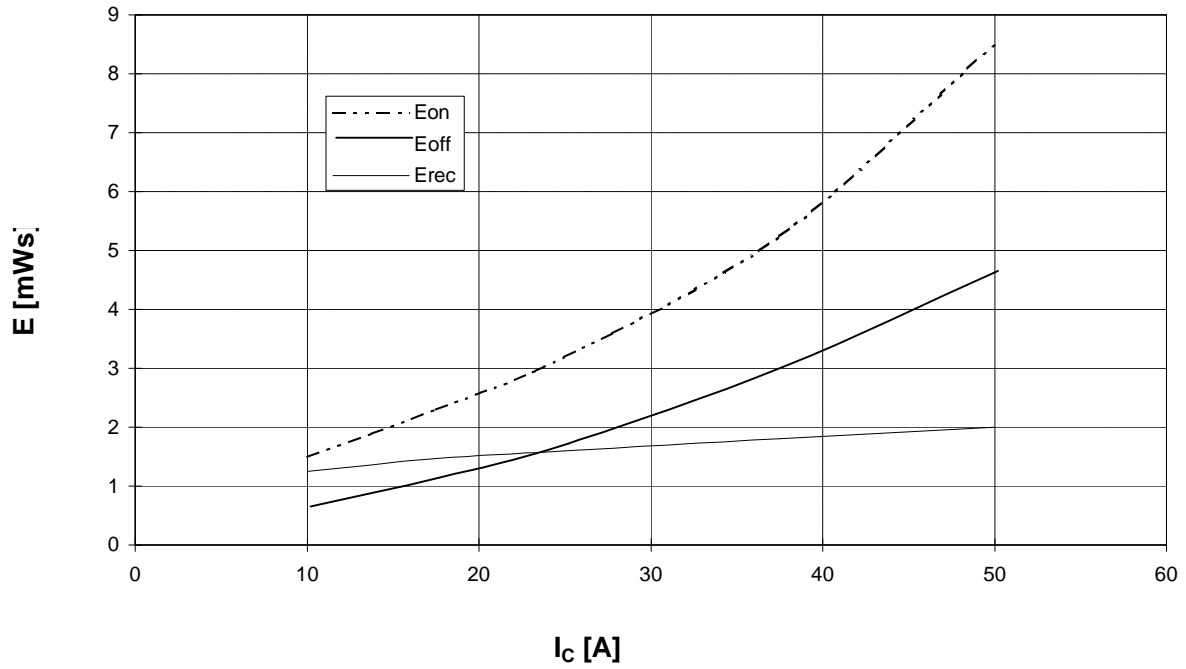

**Schaltverluste Wechselr. (typisch)**  $E_{on} = f(R_G), E_{off} = f(R_G), E_{rec} = f(R_G)$   
**Switching losses Inverter (typical)**  $T_j = 125^\circ\text{C}, V_{GE} = +15\text{ V}, I_c = I_{nenn}, V_{CC} = 600\text{ V}$

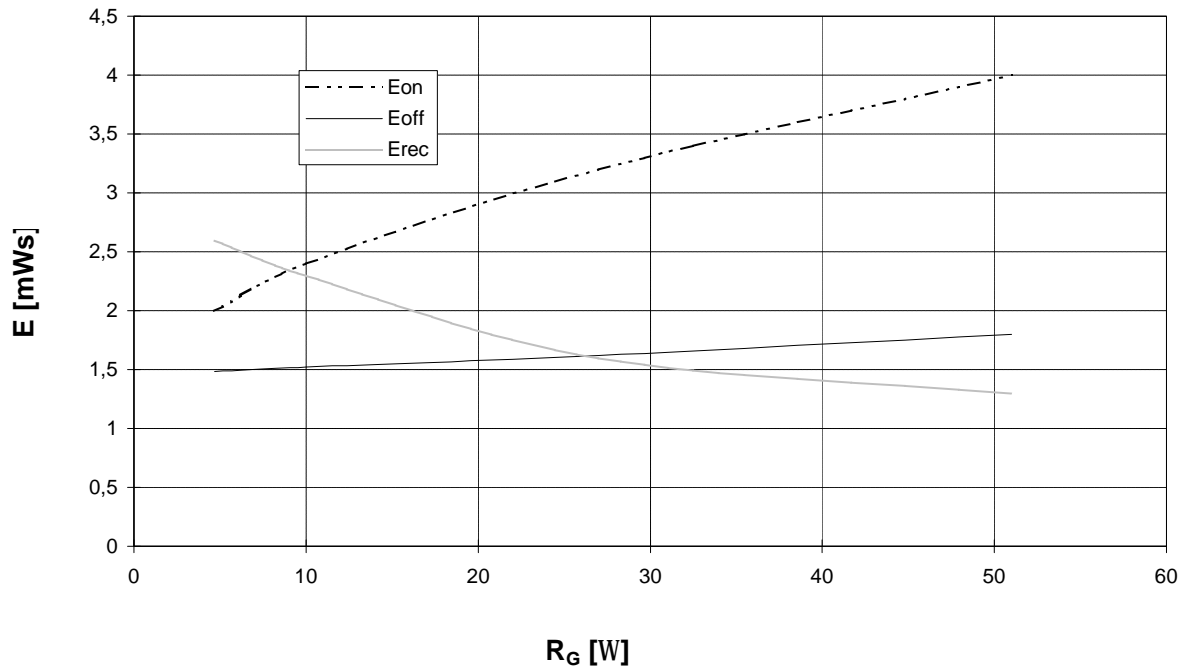



Transienter Wärmewiderstand Wechsele.  
Transient thermal impedance Inverter

$Z_{thJC} = f(t)$

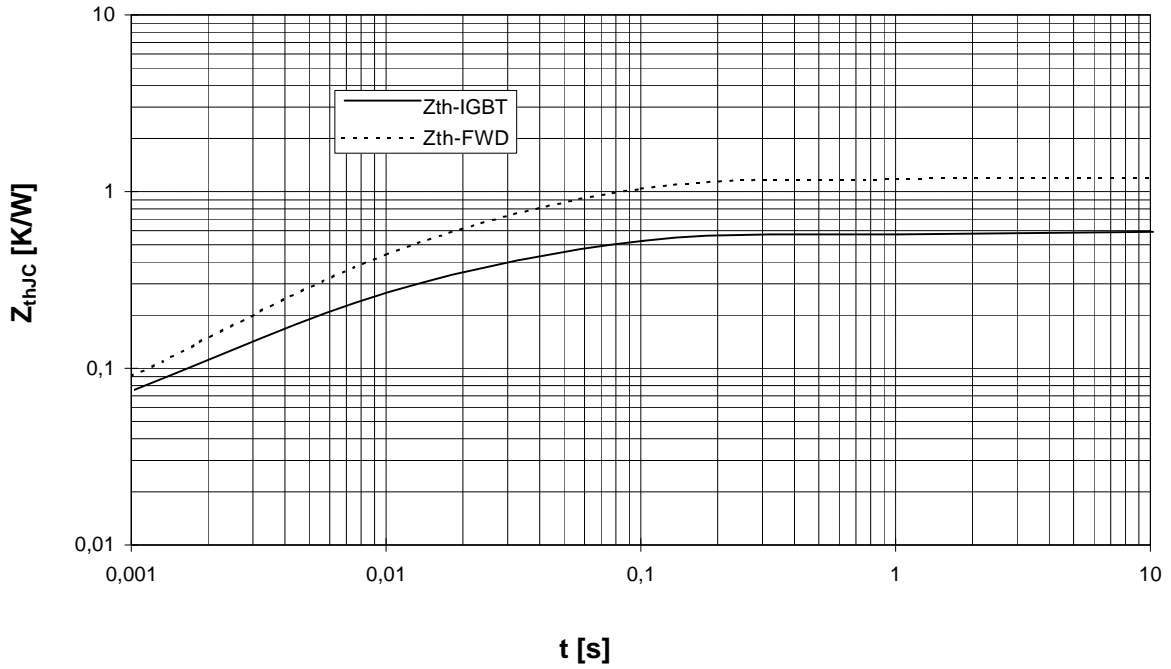

Sicherer Arbeitsbereich Wechsele. (RBSOA)

$I_C = f(V_{CE})$

Reverse bias safe operating area Inverter (RBSOA)  $T_{vi} = 125^\circ\text{C}$ ,  $V_{GE} = \pm 15\text{V}$ ,  $R_G = 27\ \text{Ohm}$

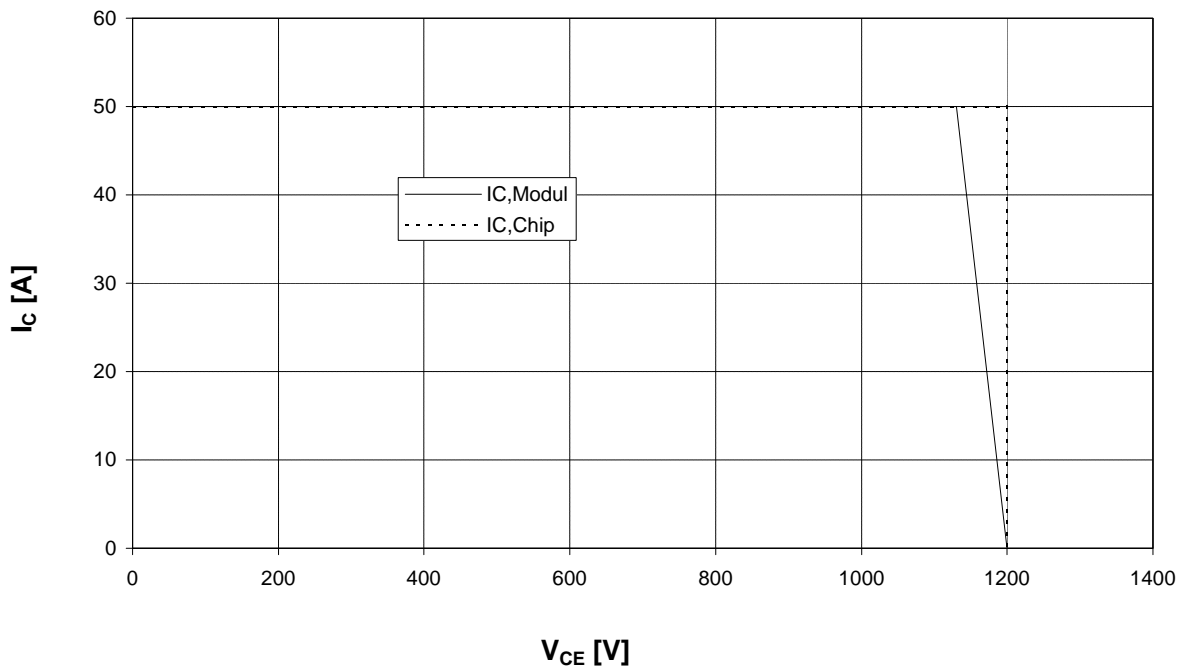



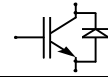

**Ausgangskennlinienfeld Brems-Chopper-IGBT (typisch)**  
**Output characteristic brake-chopper-IGBT (typical)**

$I_C = f(V_{CE})$   
 $V_{GE} = 15\text{ V}$

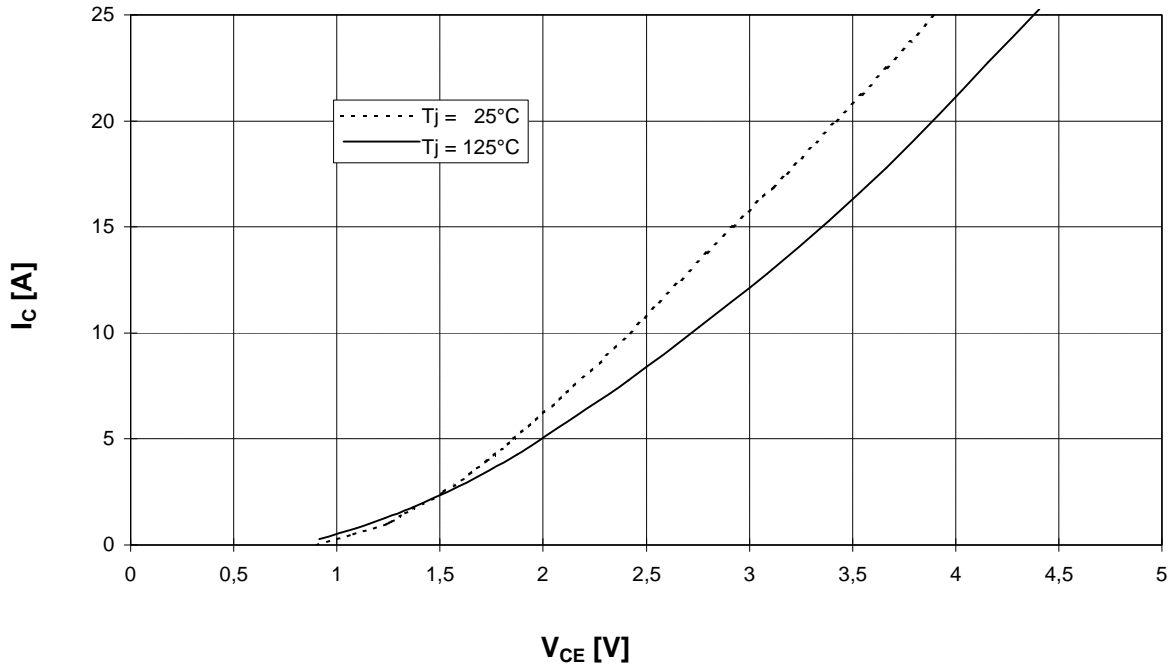

**Durchlaßkennlinie der Brems-Chopper-Diode (typisch)**  
**Forward characteristic of brake-chopper-FWD (typical)**

$I_F = f(V_F)$

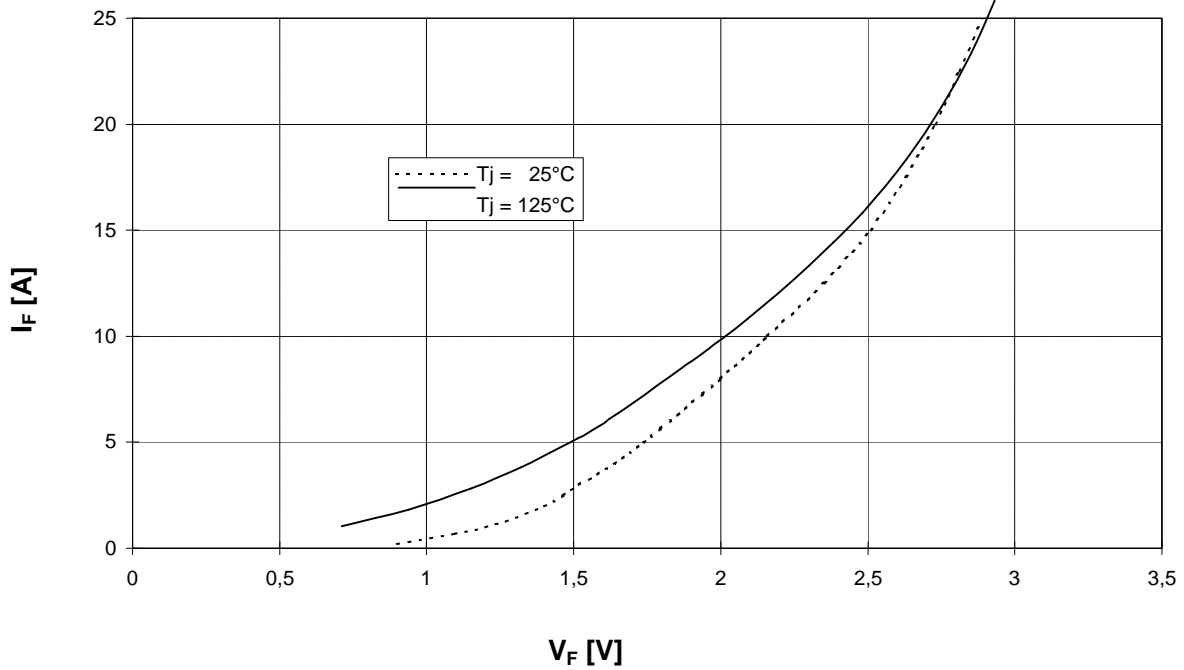



Durchlaßkennlinie der Gleichrichterdiode (typisch)  $I_F = f(V_F)$   
Forward characteristic of Rectifier Diode (typical)

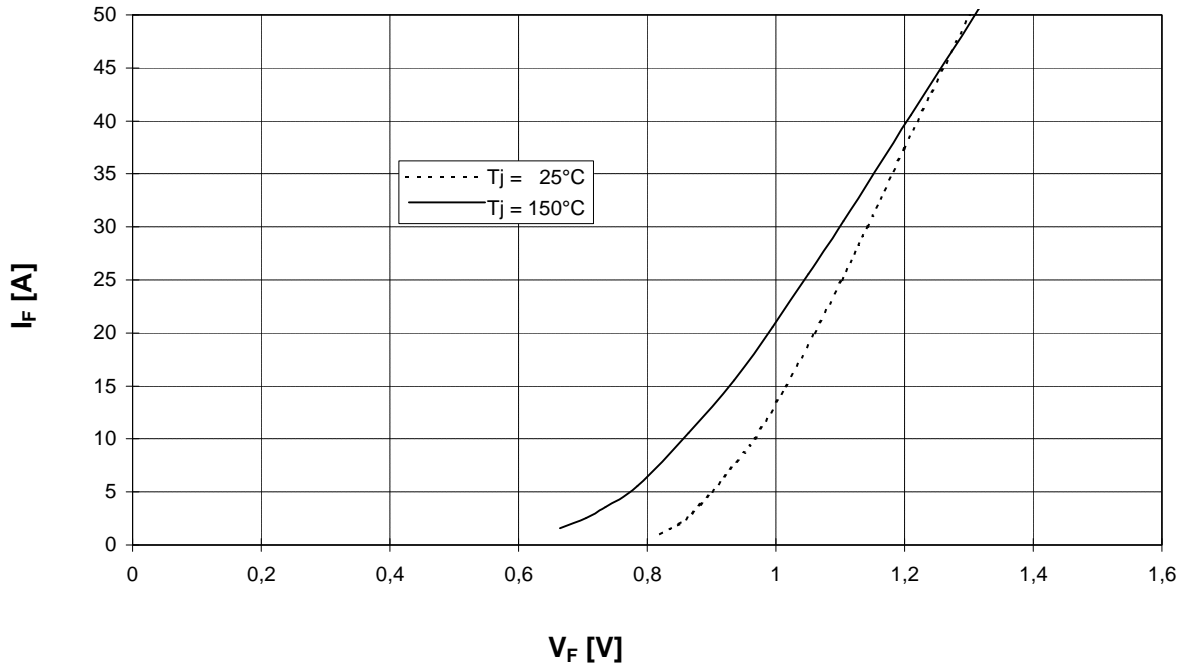

NTC- Temperaturkennlinie (typisch)  $R = f(T)$   
NTC- temperature characteristic (typical)



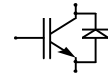

Schaltplan/ Circuit diagram

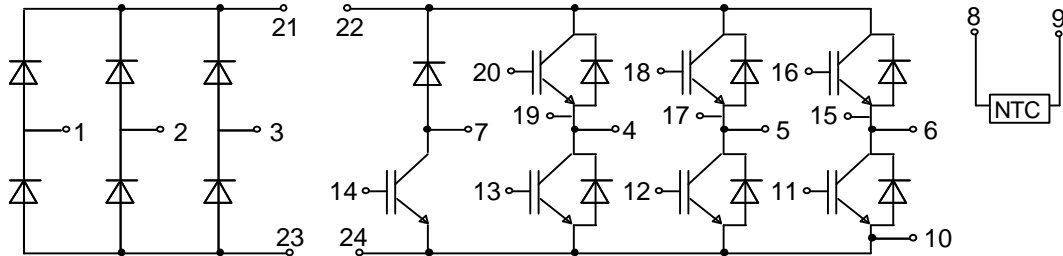

Gehäuseabmessungen/ Package outlines

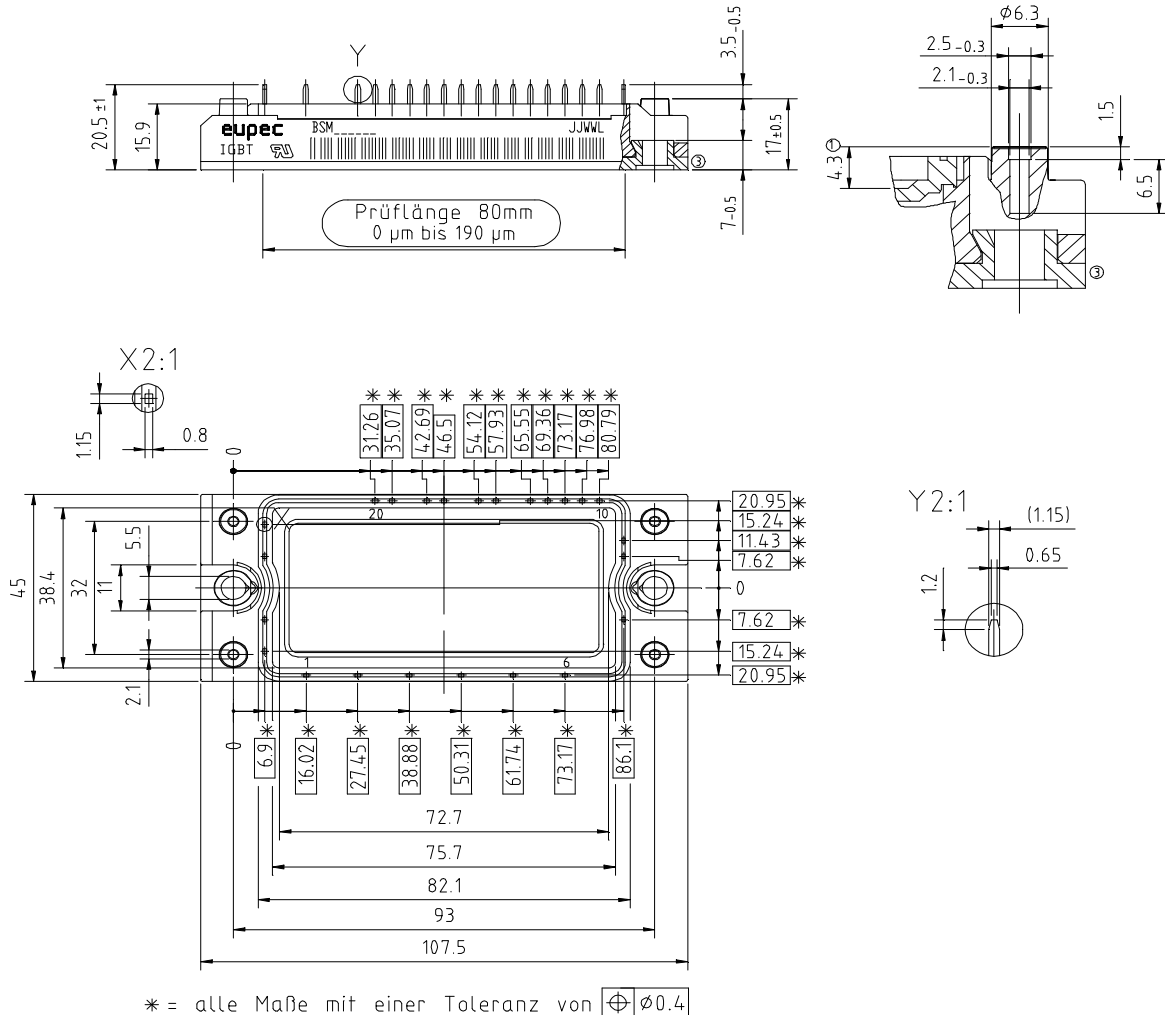

Mit dieser technischen Information werden Halbleiterbauelemente spezifiziert, jedoch keine Eigenschaften zugesichert. Sie gilt in Verbindung mit den zugehörigen Technischen Erläuterungen.

This technical information specifies semiconductor devices but promises no characteristics. It is valid in combination with the belonging technical notes.

## Nutzungsbedingungen

Die in diesem Produktdatenblatt enthaltenen Daten sind ausschließlich für technisch geschultes Fachpersonal bestimmt. Die Beurteilung der Geeignetheit dieses Produktes für die von Ihnen anvisierte Anwendung sowie die Beurteilung der Vollständigkeit der bereitgestellten Produktdaten für diese Anwendung obliegt Ihnen bzw. Ihren technischen Abteilungen.

In diesem Produktdatenblatt werden diejenigen Merkmale beschrieben, für die wir eine liefervertragliche Gewährleistung übernehmen. Eine solche Gewährleistung richtet sich ausschließlich nach Maßgabe der im jeweiligen Liefervertrag enthaltenen Bestimmungen. Garantien jeglicher Art werden für das Produkt und dessen Eigenschaften keinesfalls übernommen.

Sollten Sie von uns Produktinformationen benötigen, die über den Inhalt dieses Produktdatenblatts hinausgehen und insbesondere eine spezifische Verwendung und den Einsatz dieses Produktes betreffen, setzen Sie sich bitte mit dem für Sie zuständigen Vertriebsbüro in Verbindung (siehe [www.eupec.com](http://www.eupec.com), Vertrieb&Kontakt). Für Interessenten halten wir Application Notes bereit.

Aufgrund der technischen Anforderungen könnte unser Produkt gesundheitsgefährdende Substanzen enthalten. Bei Rückfragen zu den in diesem Produkt jeweils enthaltenen Substanzen setzen Sie sich bitte ebenfalls mit dem für Sie zuständigen Vertriebsbüro in Verbindung.

Sollten Sie beabsichtigen, das Produkt in Anwendungen der Luftfahrt, in gesundheits- oder lebensgefährdenden oder lebenserhaltenden Anwendungsbereichen einzusetzen, bitten wir um Mitteilung. Wir weisen darauf hin, dass wir für diese Fälle

- die gemeinsame Durchführung eines Risiko- und Qualitätsassessments;
- den Abschluss von speziellen Qualitätssicherungsvereinbarungen;
- die gemeinsame Einführung von Maßnahmen zu einer laufenden Produktbeobachtung dringend empfehlen und gegebenenfalls die Belieferung von der Umsetzung solcher Maßnahmen abhängig machen.

Soweit erforderlich, bitten wir Sie, entsprechende Hinweise an Ihre Kunden zu geben.

Inhaltliche Änderungen dieses Produktdatenblatts bleiben vorbehalten.

## Terms & Conditions of usage

The data contained in this product data sheet is exclusively intended for technically trained staff. You and your technical departments will have to evaluate the suitability of the product for the intended application and the completeness of the product data with respect to such application.

This product data sheet is describing the characteristics of this product for which a warranty is granted. Any such warranty is granted exclusively pursuant the terms and conditions of the supply agreement. There will be no guarantee of any kind for the product and its characteristics.

Should you require product information in excess of the data given in this product data sheet or which concerns the specific application of our product, please contact the sales office, which is responsible for you (see [www.eupec.com](http://www.eupec.com), sales&contact). For those that are specifically interested we may provide application notes.

Due to technical requirements our product may contain dangerous substances. For information on the types in question please contact the sales office, which is responsible for you.

Should you intend to use the Product in aviation applications, in health or life endangering or life support applications, please notify.

Please note, that for any such applications we urgently recommend

- to perform joint Risk and Quality Assessments;
- the conclusion of Quality Agreements;
- to establish joint measures of an ongoing product survey, and that we may make delivery depended on the realization of any such measures.

If and to the extent necessary, please forward equivalent notices to your customers.

Changes of this product data sheet are reserved.