

MITSUBISHI HVIGBT MODULES  
**CM800E2C-66H**

HIGH POWER SWITCHING USE  
 INSULATED TYPE

2nd-Version HVIGBT (High Voltage Insulated Gate Bipolar Transistor) Modules

**CM800E2C-66H**



- IC.....800A
- VCES ..... 3300V
- Insulated Type
- 1-elements in a pack (for brake)
- AISiC base plate

**APPLICATION**

DC choppers, Dynamic braking choppers.

**OUTLINE DRAWING & CIRCUIT DIAGRAM**

Dimensions in mm

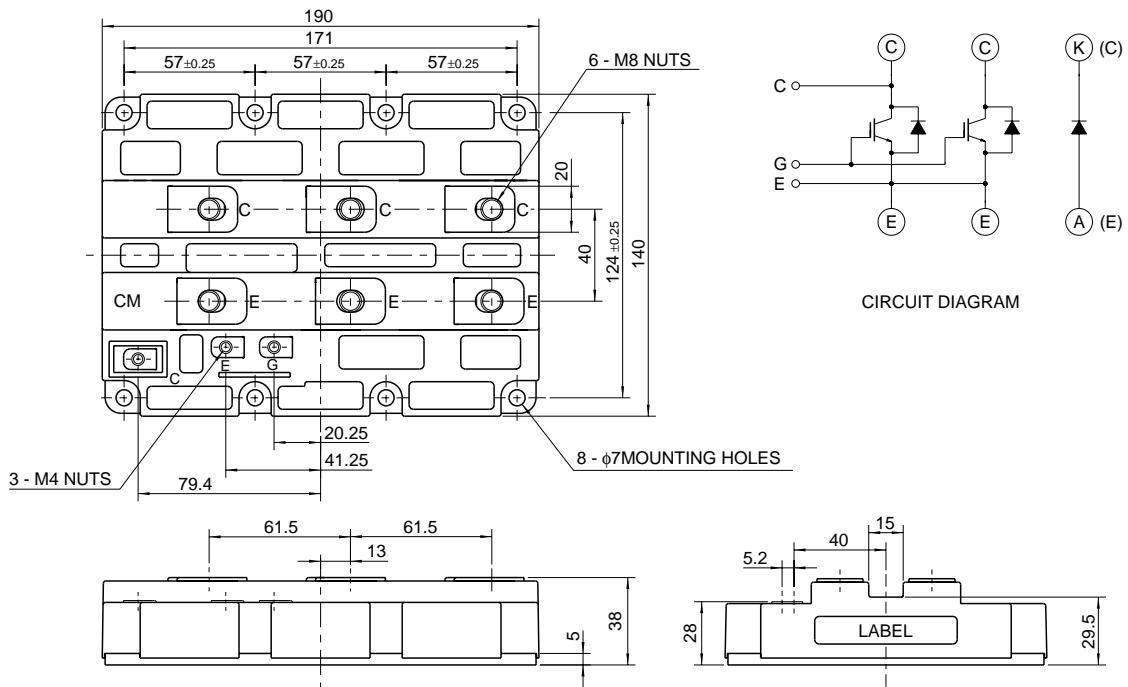

HVIGBT MODULES (High Voltage Insulated Gate Bipolar Transistor Modules)

Mar. 2003

**CM800E2C-66H**

**HIGH POWER SWITCHING USE  
INSULATED TYPE**

2nd-Version HVIGBT (High Voltage Insulated Gate Bipolar Transistor) Modules

**MAXIMUM RATINGS (Tj = 25°C)**

| Symbol                   | Item                          | Conditions   | Ratings      | Unit |
|--------------------------|-------------------------------|--|--------------|------|
| V <sub>CE</sub> S        | Collector-emitter voltage     | V <sub>GE</sub> = 0V                                       | 3300         | V    |
| V <sub>GE</sub> S        | Gate-emitter voltage          | V <sub>CE</sub> = 0V                                       | ±20          | V    |
| I <sub>C</sub>           | Collector current             | DC, T <sub>C</sub> = 95°C                                  | 800          | A    |
| I <sub>CM</sub>          |                               | Pulse (Note 1)   | 1600         | A    |
| I <sub>E</sub> (Note 2)  | Emitter current               | —  | 800          | A    |
| I <sub>EM</sub> (Note 2) |                               | Pulse (Note 1)   | 1600         | A    |
| P <sub>C</sub> (Note 3)  | Maximum collector dissipation | T <sub>C</sub> = 25°C, IGBT part                           | 9600         | W    |
| T <sub>j</sub>           | Junction temperature          | —  | -40 ~ +150   | °C   |
| T <sub>stg</sub>         | Storage temperature           | —  | -40 ~ +125   | °C   |
| V <sub>iso</sub>         | Isolation voltage             | Charged part to base plate, rms, sinusoidal, AC 60Hz 1min. | 6000         | V    |
| —                        | Mounting torque               | Main terminals screw M8                                    | 6.67 ~ 13.00 | N·m  |
|                          |                               | Mounting screw M6  | 2.84 ~ 6.00  | N·m  |
|                          |                               | Auxiliary terminals screw M4                               | 0.88 ~ 2.00  | N·m  |
| —                        | Mass                          | Typical value  | 1.5          | kg   |

**ELECTRICAL CHARACTERISTICS (Tj = 25°C)**

| Symbol                   | Item                                 | Conditions  | Limits |       |       | Unit |
|--------------------------|--------------------------------------|---|--------|-------|-------|------|
|                          |                                      |   | Min    | Typ   | Max   |      |
| I <sub>CE</sub> S        | Collector cutoff current             | V <sub>CE</sub> = V <sub>CE</sub> S, V <sub>GE</sub> = 0V             | —      | —     | 10    | mA   |
| V <sub>GE(th)</sub>      | Gate-emitter threshold voltage       | I <sub>C</sub> = 80mA, V <sub>CE</sub> = 10V                          | 4.5    | 6.0   | 7.5   | V    |
| I <sub>GE</sub> S        | Gate-leakage current                 | V <sub>GE</sub> = V <sub>GE</sub> S, V <sub>CE</sub> = 0V             | —      | —     | 0.5   | μA   |
| V <sub>CE(sat)</sub>     | Collector-emitter saturation voltage | T <sub>j</sub> = 25°C   | —      | 3.80  | 4.94  | V    |
|                          |                                      | T <sub>j</sub> = 125°C  | —      | 4.00  | —     |      |
| C <sub>ies</sub>         | Input capacitance                    | V <sub>CE</sub> = 10V<br>V <sub>GE</sub> = 0V                         | —      | 120   | —     | nF   |
| C <sub>oes</sub>         | Output capacitance                   |   | —      | 12.0  | —     | nF   |
| C <sub>res</sub>         | Reverse transfer capacitance         |   | —      | 3.6   | —     | nF   |
| Q <sub>G</sub>           | Total gate charge                    | V <sub>CC</sub> = 1650V, I <sub>C</sub> = 800A, V <sub>GE</sub> = 15V | —      | 5.7   | —     | μC   |
| t <sub>d(on)</sub>       | Turn-on delay time                   | V <sub>CC</sub> = 1650V, I <sub>C</sub> = 800A                        | —      | —     | 1.60  | μs   |
| t <sub>r</sub>           | Turn-on rise time                    | V <sub>GE1</sub> = V <sub>GE2</sub> = 15V                             | —      | —     | 2.00  | μs   |
| t <sub>d(off)</sub>      | Turn-off delay time                  | R <sub>G</sub> = 2.5Ω   | —      | —     | 2.50  | μs   |
| t <sub>f</sub>           | Turn-off fall time                   | Resistive load switching operation                                    | —      | —     | 1.00  | μs   |
| V <sub>EC</sub> (Note 2) | Emitter-collector voltage            | I <sub>E</sub> = 800A, V <sub>GE</sub> = 0V                           | —      | 2.80  | 3.64  | V    |
| t <sub>rr</sub> (Note 2) | Reverse recovery time                | I <sub>E</sub> = 800A   | —      | —     | 1.40  | μs   |
| Q <sub>rr</sub> (Note 2) | Reverse recovery charge              | di <sub>E</sub> / dt = -1600A / μs                                    | —      | 270   | —     | μC   |
| R <sub>th(j-c)Q</sub>    | Thermal resistance                   | Junction to case, IGBT part   | —      | —     | 0.013 | K/W  |
| R <sub>th(j-c)R</sub>    |                                      | Junction to case, FWDi part   | —      | —     | 0.025 | K/W  |
| R <sub>th(c-f)</sub>     | Contact thermal resistance           | Case to fin, conductive grease applied (Per 2/3 module)               | —      | 0.008 | —     | K/W  |
| V <sub>FM</sub>          | Forward voltage                      | I <sub>F</sub> = 800A, Clamp diode part                               | —      | 3.00  | 3.90  | V    |
| t <sub>rr</sub>          | Reverse recovery time                | I <sub>F</sub> = 800A   | —      | —     | 1.40  | μs   |
| Q <sub>rr</sub>          | Reverse recovery charge              | di <sub>F</sub> / dt = -1600A / μs, Clamp diode part                  | —      | 270   | —     | μC   |
| R <sub>th(j-c)</sub>     | Thermal resistance                   | Junction to case, Clamp diode part                                    | —      | —     | 0.025 | K/W  |
| R <sub>th(c-f)</sub>     | Contact thermal resistance           | Case to fin, conductive grease applied (Per 1/3 module)               | —      | 0.008 | —     | K/W  |

- Note 1. Pulse width and repetition rate should be such that the device junction temp. (T<sub>j</sub>) does not exceed T<sub>jmax</sub> rating.  
 2. I<sub>E</sub>, V<sub>EC</sub>, t<sub>rr</sub>, Q<sub>rr</sub> & di<sub>E</sub>/dt represent characteristics of the anti-parallel, emitter to collector free-wheel diode.  
 3. Junction temperature (T<sub>j</sub>) should not increase beyond 150°C.  
 4. Pulse width and repetition rate should be such as to cause negligible temperature rise.

# CM800E2C-66H

HIGH POWER SWITCHING USE  
INSULATED TYPE

2nd-Version HVIGBT (High Voltage Insulated Gate Bipolar Transistor) Modules

## PERFORMANCE CURVES

**OUTPUT CHARACTERISTICS (TYPICAL)**

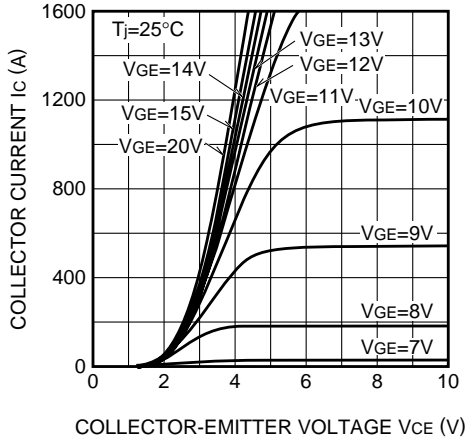

**TRANSFER CHARACTERISTICS (TYPICAL)**

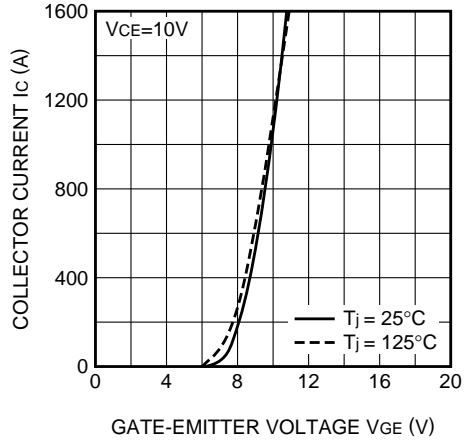

**COLLECTOR-EMITTER SATURATION VOLTAGE CHARACTERISTICS (TYPICAL)**

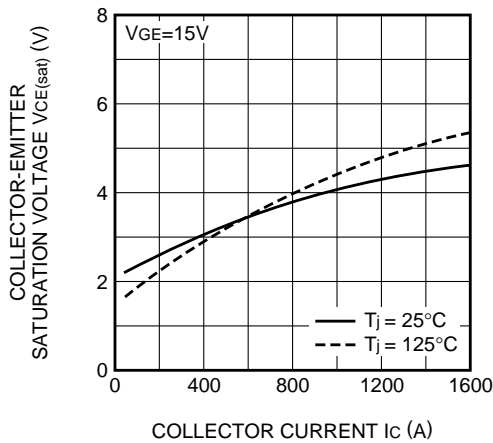

**COLLECTOR-EMITTER SATURATION VOLTAGE CHARACTERISTICS (TYPICAL)**

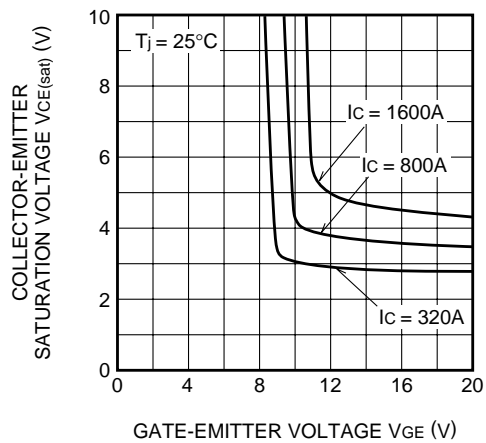

**FREE-WHEEL DIODE FORWARD CHARACTERISTICS (TYPICAL)**

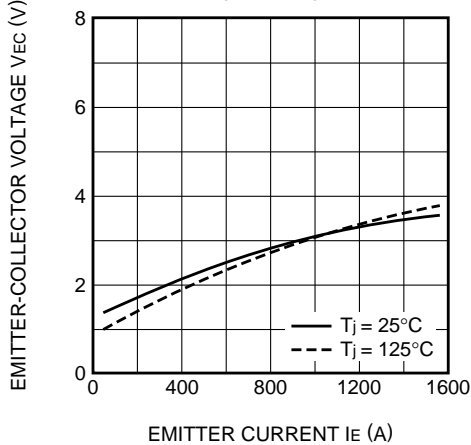

**CAPACITANCE CHARACTERISTICS (TYPICAL)**

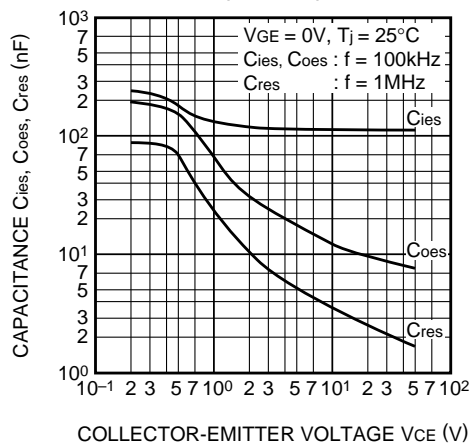

# CM800E2C-66H

HIGH POWER SWITCHING USE  
INSULATED TYPE

2nd-Version HVIGBT (High Voltage Insulated Gate Bipolar Transistor) Modules

