

Single Phase Rectifier Bridge

Standard and Avalanche Types

$I_{dAV} = 18 \text{ A}$
 $V_{RRM} = 800-1600 \text{ V}$

V_{RSM} V	V_{BRmin} ① V	V_{RRM} V	Standard Types	Avalanche Types
900		800	VBO 13-08NO2	
1300	1230	1200	VBO 13-12NO2	VBO 13-12AO2
1500	1430	1400	VBO 13-14NO2	VBO 13-14AO2
1700	1630	1600	VBO 13-16NO2	VBO 13-16AO2

① For Avalanche Types only

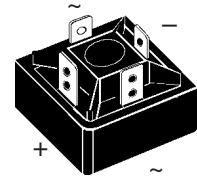
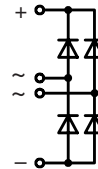

Symbol	Conditions	Maximum Ratings	Features	
I_{dAV} ②	$T_C = 85^\circ\text{C}$, module	18 A	<ul style="list-style-type: none"> Avalanche rated parts available Package with DCB ceramic base plate Isolation voltage 3600 V~ Planar passivated chips Low forward voltage drop 1/4" fast-on terminals UL registered E 72873 	
I_{dAVM}	module	30 A		
P_{RSM}	$T_{VJ} = T_{VJM}$ t = 10 μs	2.5 kW		
I_{FSM}	$T_{VJ} = 45^\circ\text{C}$; $V_R = 0$	t = 10 ms (50 Hz), sine		220 A
		t = 8.3 ms (60 Hz), sine		230 A
I^2t	$T_{VJ} = 45^\circ\text{C}$; $V_R = 0$	t = 10 ms (50 Hz), sine		180 A
		t = 8.3 ms (60 Hz), sine		190 A
T_{VJ}	$T_{VJ} = T_{VJM}$; $V_R = 0$	t = 10 ms (50 Hz), sine		240 A ² s
		t = 8.3 ms (60 Hz), sine		220 A ² s
T_{VJM}	$T_{VJ} = T_{VJM}$	160 A ² s		
T_{stg}	$V_R = 0$	150 A ² s		
V_{ISOL}	50/60 Hz, RMS t = 1 min $I_{ISOL} \leq 1 \text{ mA}$ t = 1 s	3000 V~		
		3600 V~		
M_d	Mounting torque (M5) (10-32 UNF)	1.5-2 Nm 13-18 lb.in.		
Weight	typ.	15 g		

Features

- Avalanche rated parts available
- Package with DCB ceramic base plate
- Isolation voltage 3600 V~
- Planar passivated chips
- Low forward voltage drop
- 1/4" fast-on terminals
- UL registered E 72873

Applications

- Supplies for DC power equipment
- Input rectifiers for PWM inverter
- Battery DC power supplies
- Field supply for DC motors

Advantages

- Easy to mount with one screw
- Space and weight savings
- Improved temperature and power cycling

Dimensions in mm (1 mm = 0.0394")

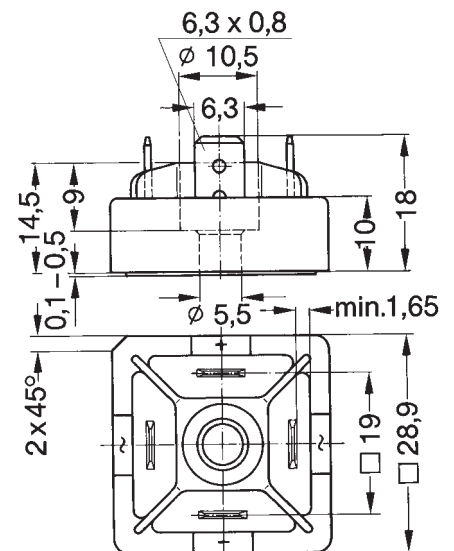

Symbol	Test Conditions	Characteristic Values
I_R	$V_R = V_{RRM}$; $T_{VJ} = 25^\circ\text{C}$	$\leq 0.3 \text{ mA}$
	$V_R = V_{RRM}$; $T_{VJ} = T_{VJM}$	$\leq 5 \text{ mA}$
V_F	$I_F = 55 \text{ A}$; $T_{VJ} = 25^\circ\text{C}$	$\leq 1.8 \text{ V}$
V_{T0}	For power-loss calculations only	0.85 V
r_T	$T_{VJ} = T_{VJM}$	17 m Ω
R_{thJC}	per diode; DC current	5.6 K/W
	per module	1.4 K/W
R_{thJK}	per diode; DC current	6.0 K/W
	per module	1.5 K/W
d_s	Creeping distance on surface	13 mm
d_A	Creepage distance in air ③	9.5 mm
a	Max. allowable acceleration	50 m/s ²

Data according to IEC 60747 and refer to a single diode unless otherwise stated
 ② for resistive load at bridge output, ③ with isolated fast-on tabs.

IXYS reserves the right to change limits, test conditions and dimensions.

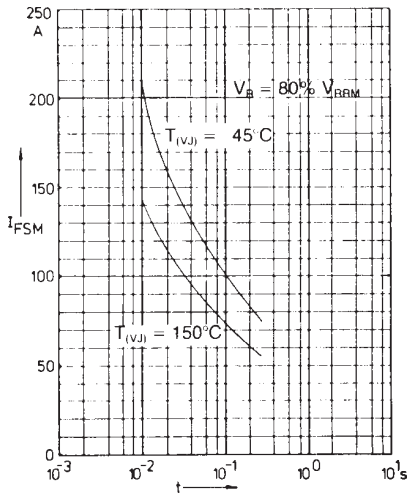

Fig. 1 Surge overload current per diode
 I_{FSM} : Crest value, t : duration

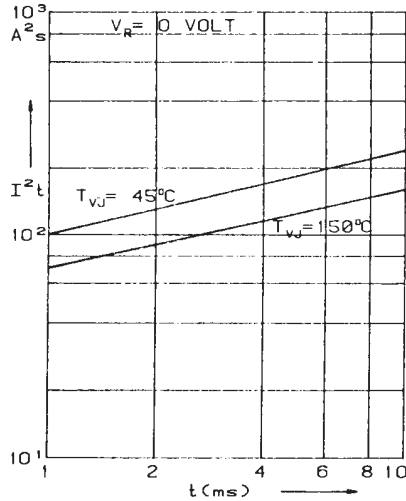

Fig. 2 I^2t versus time (1-10 ms) per diode

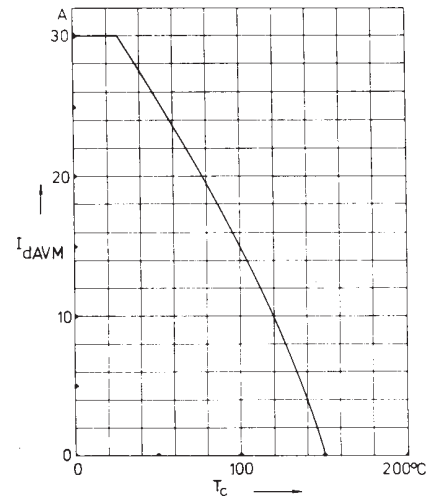

Fig. 3 Max. forward current at case temperature

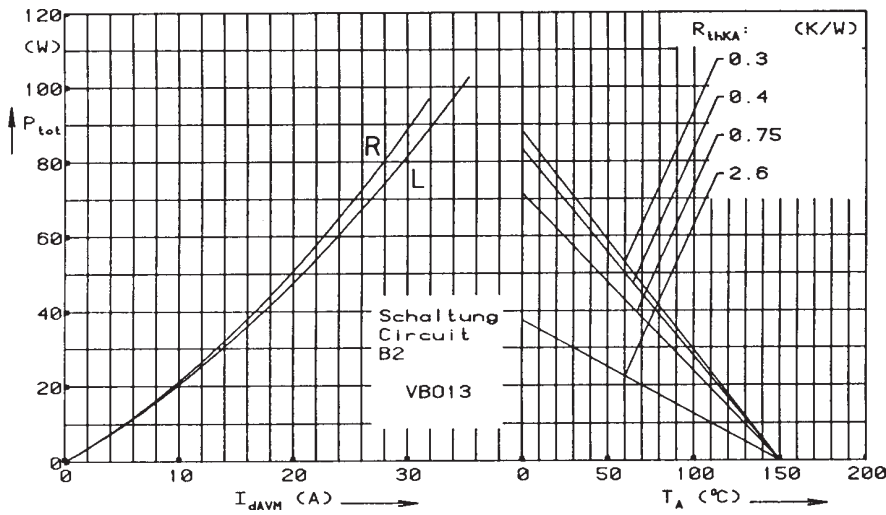

Fig. 4 Power dissipation versus direct output current and ambient temperature

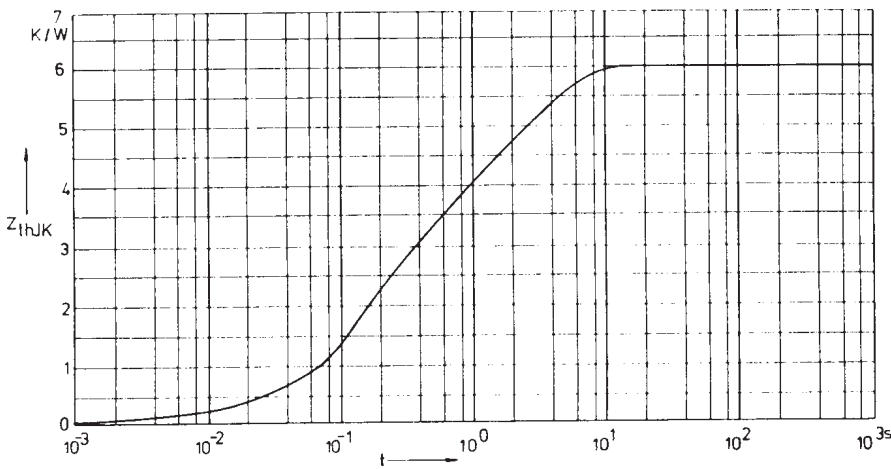

Fig. 5 Transient thermal impedance junction to heatsink per diode

Constants for Z_{thJK} calculation:

i	R_{thi} (K/W)	t_i (s)
1	0.059	0.00217
2	2.714	0.159
3	3.227	2.34