

ECO-PAC™

Three Phase Rectifier Bridge

with Fast Recovery Epitaxial Diodes (FRED)

$I_{dAV} = 40 \text{ A}$
 $V_{RRM} = 1200 \text{ V}$
 $t_{rr} = 40 \text{ ns}$

V_{RSM} V	V_{RRM} V	Type
1200	1200	VUE 35-12NO7

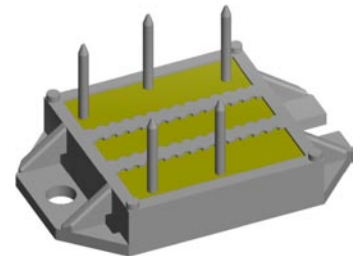
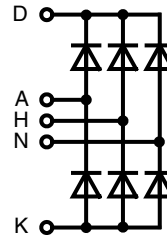

Symbol	Conditions	Maximum Ratings	
I_{dAV} ①	$T_C = 85^\circ\text{C}$, module	40	A
I_{dAVM}		90	A
I_{FSM}	$T_{VJ} = 45^\circ\text{C}$; $t = 10 \text{ ms}$ (50 Hz)	90	A
	$V_R = 0$; $t = 8.3 \text{ ms}$ (60 Hz)	100	A
	$T_{VJ} = 125^\circ\text{C}$; $t = 10 \text{ ms}$ (50 Hz)	75	A
	$V_R = 0$; $t = 8.3 \text{ ms}$ (60 Hz)	85	A
I^2t	$T_{VJ} = 45^\circ\text{C}$; $t = 10 \text{ ms}$ (50 Hz)	40	A ² s
	$V_R = 0$; $t = 8.3 \text{ ms}$ (60 Hz)	40	A ² s
	$T_{VJ} = 125^\circ\text{C}$; $t = 10 \text{ ms}$ (50 Hz)	30	A ² s
	$V_R = 0$; $t = 8.3 \text{ ms}$ (60 Hz)	30	A ² s
T_{VJ}		-40...+150	°C
T_{VJM}		150	°C
T_{stg}		-40...+125	°C
V_{ISOL}	50/60 Hz, RMS $t = 1 \text{ min}$	3000	V~
	$I_{ISOL} \leq 1 \text{ mA}$ $t = 1 \text{ s}$	3600	V~
M_d	Mounting torque (M4)	1.5 - 2	Nm
Weight	typ.	19	g

Features

- Package with DCB ceramic base plate in low profile
- Isolation voltage 3000 V~
- Planar passivated chips
- Low forward voltage drop
- Leads suitable for PC board soldering

Applications

- Supplies for DC power equipment
- Input and output rectifiers for high frequency
- Battery DC power supplies
- Field supply for DC motors

Advantages

- Space and weight savings
- Improved temperature and power cycling capability
- Small and light weight
- Low noise switching

Symbol	Conditions	Characteristic Values		
		(T _{VJ} = 25°C, unless otherwise specified)		
		typ.	max.	
I_R	$V_R = V_{RRM}$ $T_{VJ} = 25^\circ\text{C}$		0.1	mA
	$V_R = V_{RRM}$ $T_{VJ} = T_{VJM}$		0.5	mA
V_F	$I_F = 15 \text{ A}$ $T_{VJ} = 25^\circ\text{C}$		2.73	V
V_{T0}	For power-loss calculations only		1.32	V
r_t			30	mΩ
R_{thJC}	per diode; DC current		1.6	K/W
	per diode; DC current, typ.		0.3	K/W
I_{RM}	$I_F = 25 \text{ A}$; $-di_F/dt = 100 \text{ A}/\mu\text{s}$ $V_R = 100 \text{ V}$; $L = 0.05 \text{ mH}$; $T_{VJ} = 100^\circ\text{C}$	5	9.7	A
t_{rr}	$I_F = 1 \text{ A}$; $-di/dt = 100 \text{ A}/\mu\text{s}$; $V_R = 30 \text{ V}$; $T_{VJ} = 25^\circ\text{C}$	40	tbd	ns
d_s	Creeping distance on surface	50		m/s ²
d_A	Creepage distance in air	11.2		mm
a	Max. allowable acceleration	9.7		mm

Data according to IEC 60747 and refer to a single diode unless otherwise stated.
 ① for resistive load at bridge output.

IXYS reserves the right to change limits, test conditions and dimensions.

© IXYS All rights reserved

Dimensions in mm (1 mm = 0.0394")

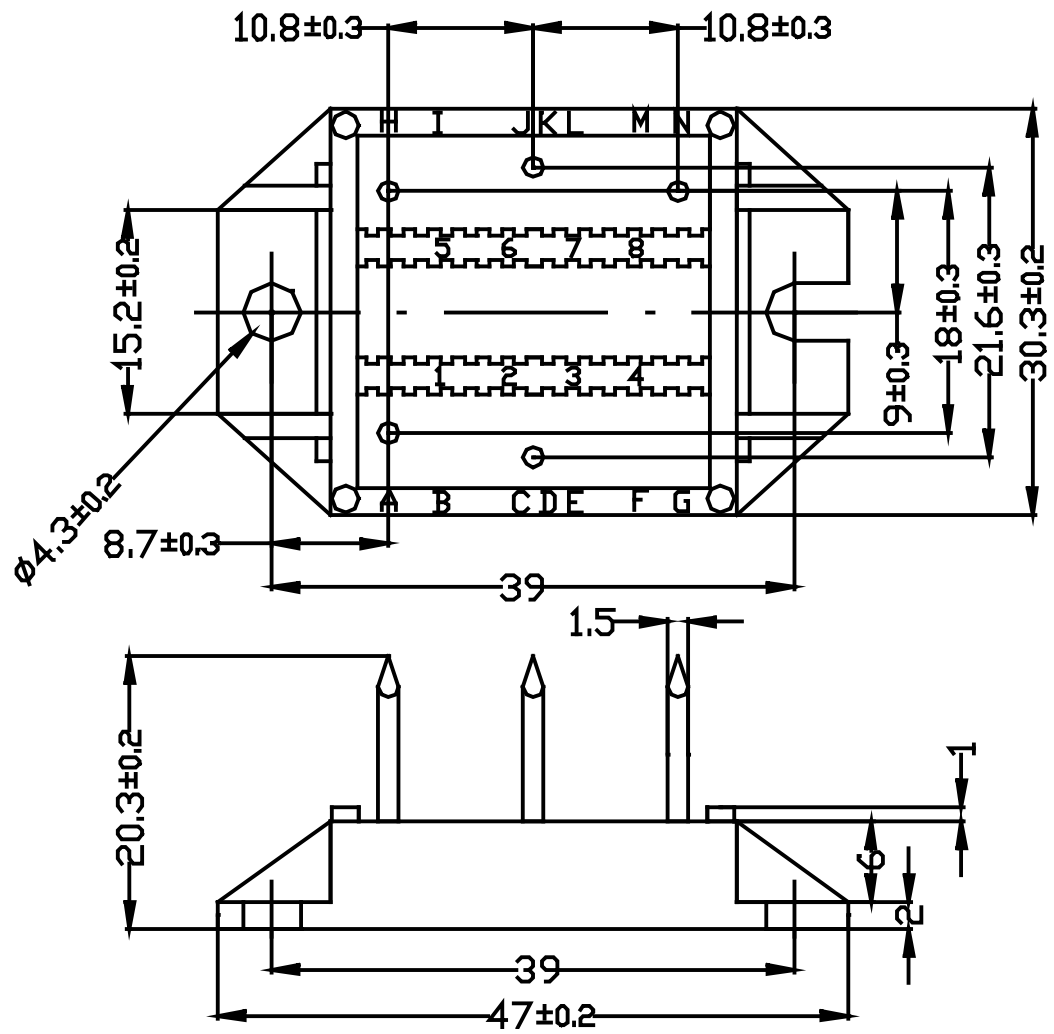

IXYS reserves the right to change limits, test conditions and dimensions.

© IXYS All rights reserved

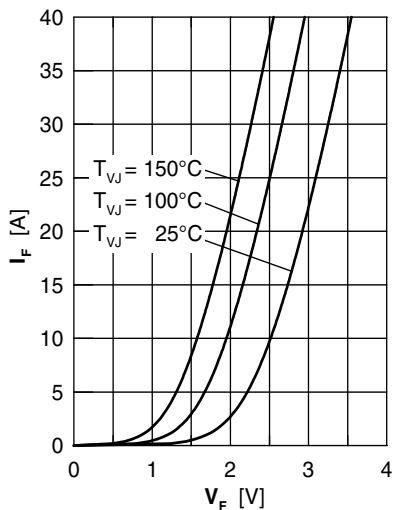

Fig. 1 Forward current I_F vs. V_F

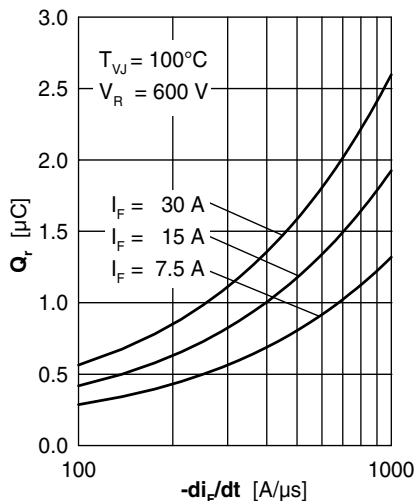

Fig. 2 Reverse recovery charge Q_r versus $-di_F/dt$

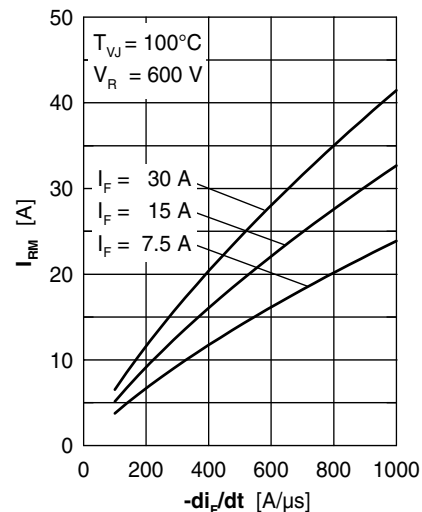

Fig. 3 Peak reverse current I_{RM} versus $-di_F/dt$

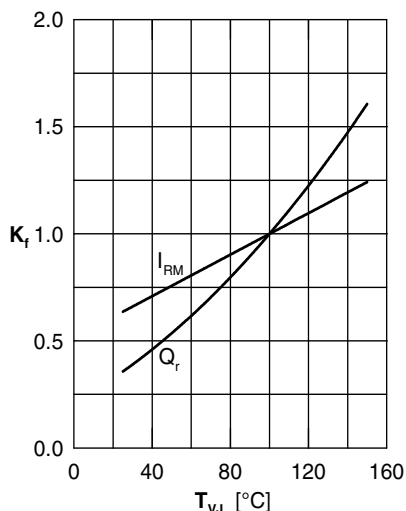

Fig. 4 Dynamic parameters Q_r , I_{RM} versus T_{VJ}

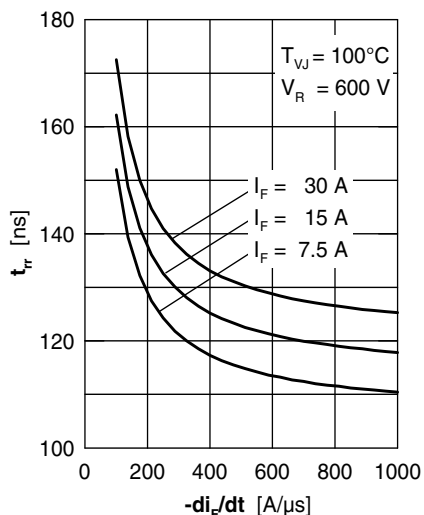

Fig. 5 Recovery time t_{tr} vs. $-di_F/dt$

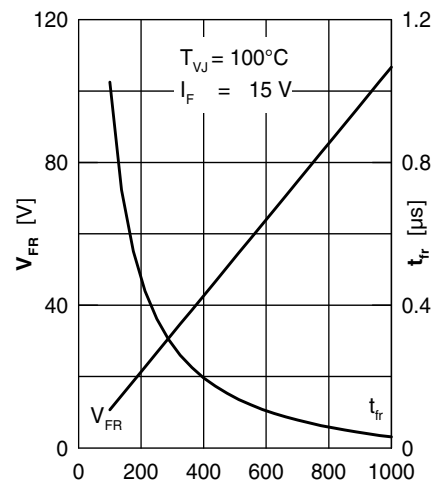

Fig. 6 Peak forward voltage V_{FR} and t_{tr} versus di_F/dt

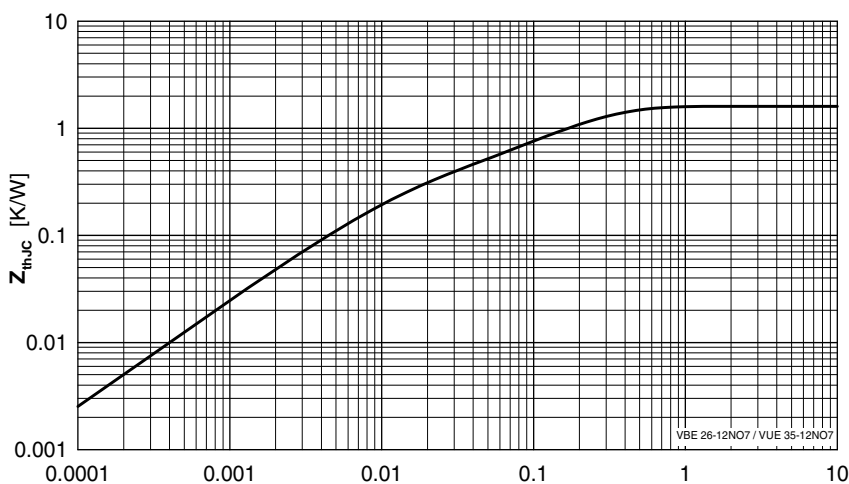

Fig. 7 Transient thermal resistance junction to case

Constants for Z_{thJC} calculation:

i	R_{thi} (K/W)	t_i (s)
1	0.5464	0.0052
2	0.2104	0.0003
3	0.0432	0.0004
4	0.8	0.0092